

Mono-Pitch Canopy

Accredited to BS EN 1090 | Load tested to BS EN 1991003:2003

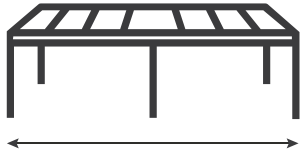

Length
Any Length

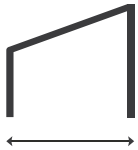

Width
Max 6m (polycarbonate roof)
Max 5m (glass roof)

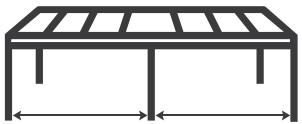

Span Between Front Posts
6m Span (max projection 3m)
4m Span (4m+ projection)

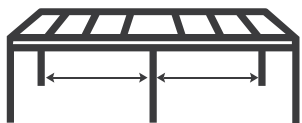

Span Between Back Posts
Max 6m





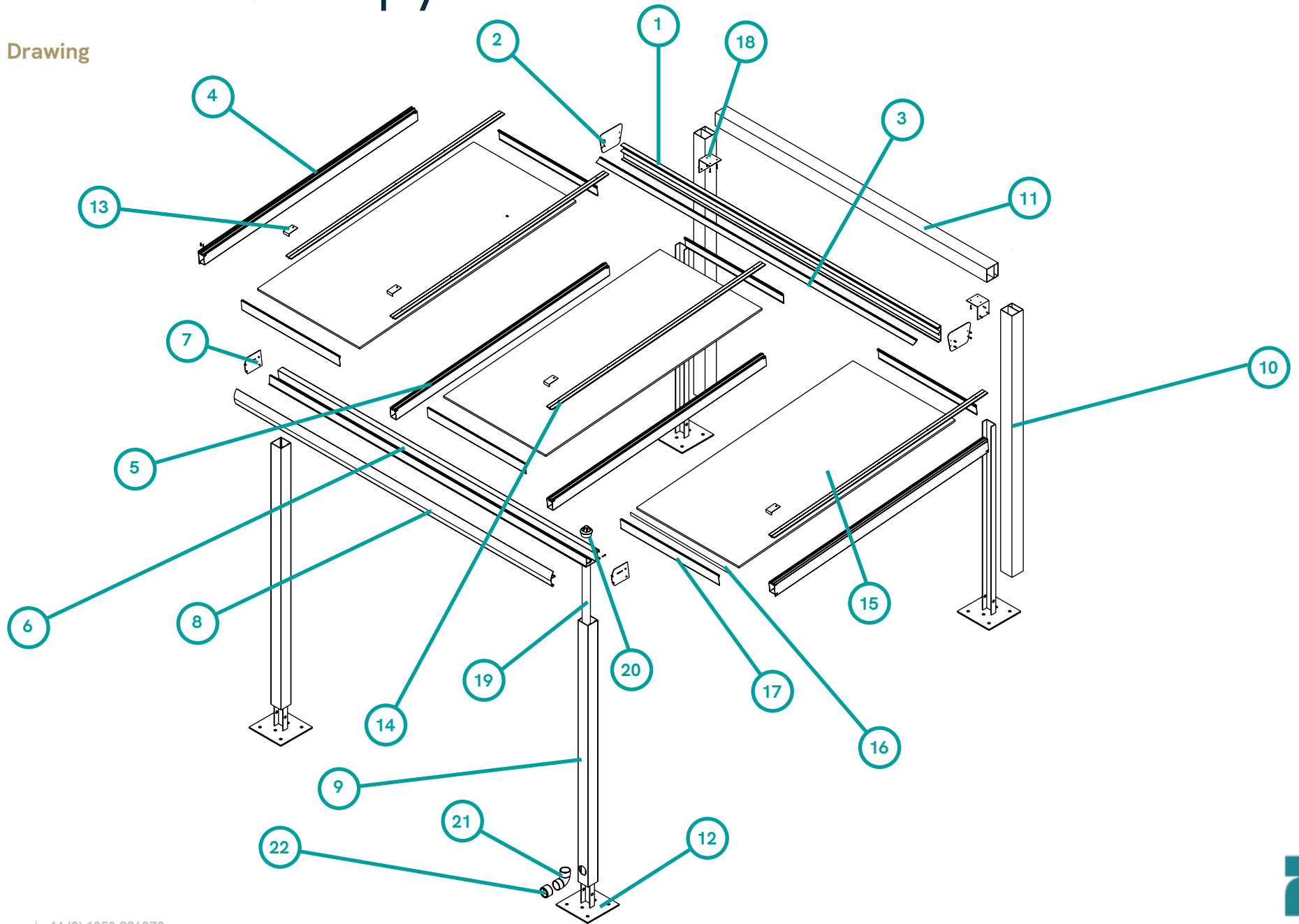

Mono-Pitch Canopy

Exploded Drawing



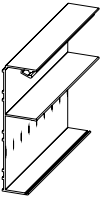
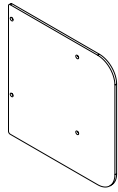
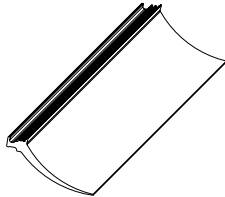
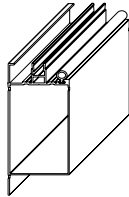
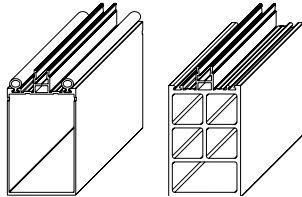
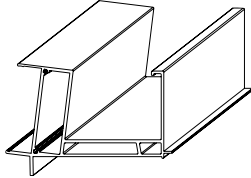
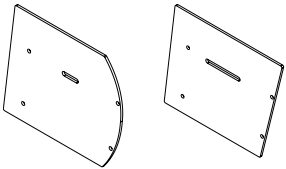
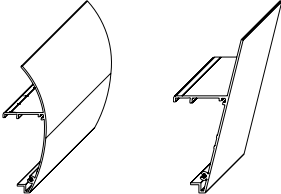

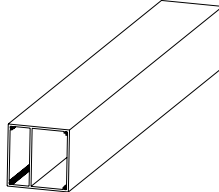
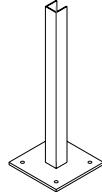
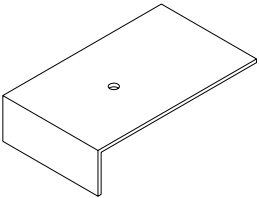
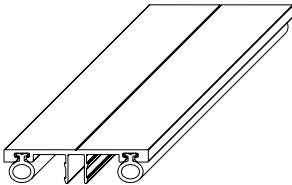
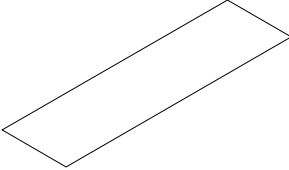
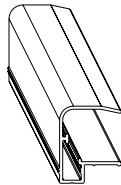
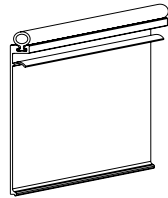
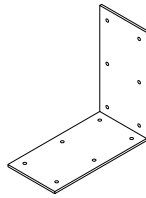
Mono-Pitch Canopy

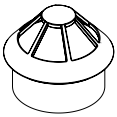
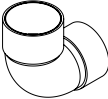
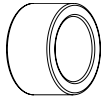
Parts List

					
1. Wall Plate	2. End Cap	3. Wall Plate Rubber	4. Side Roof Beam	5. Intermediate Roof Beam	6. Gutter
					
7. Gutter End Cap	8. Gutter Fascia	9. 110 x 110mm Square Post	10. 125 x 125mm Square Post	11. 125 x 125mm HD Square Post	12. Heavy Duty Steel Base Plate
					
13. Roof Beam Top End Cover	14. Roof beam Top Cap	15. Roof Panel	16. Nosing profile	17. Infill Fascia	18. 125 X 125mm Square Post Support Bracket
					
19. Down Pipe	20. Leaf guard	21. Elbow	22. Elbow End Cover		

Mono-Pitch Canopy

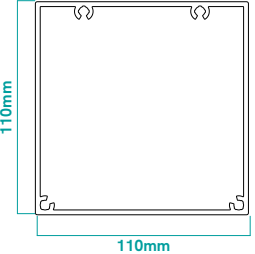
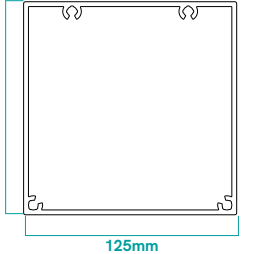
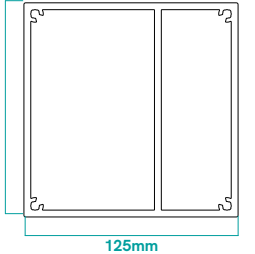
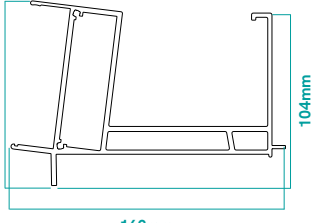
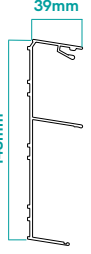
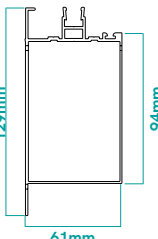
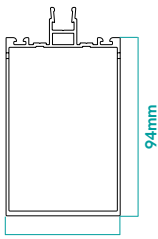
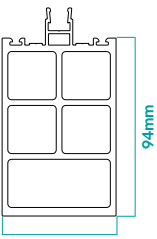
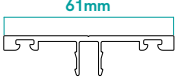
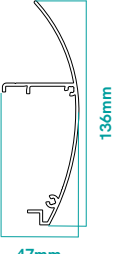
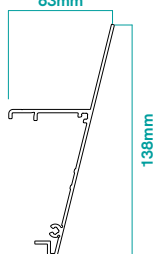
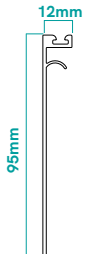
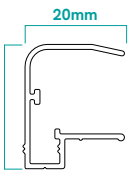
Profile Dimensions

				
1. Square Post	2. 125 x 125mm Square Post	3. 125 x 125mm Heavy Duty Square Post	4. Gutter	5. Wall Plate
				
6. Side Roof beam	7. Intermediate Roof Beam	8. Heavy Duty Intermediate Roof Beam	9. Top Cap	10. Radius Gutter Fascia
				
11. Angle Gutter Fascia	12. Infill Fascia	13. Polycarbonate Nosing Profile	14. Glass Nosing Profile	

Mono-Pitch Canopy

Fixing Details

