

## Bioclimatic Pergola

EN13561 Wind Class 6 Rated  
Snow Zone 3 Rated

### Configuration and size parameters

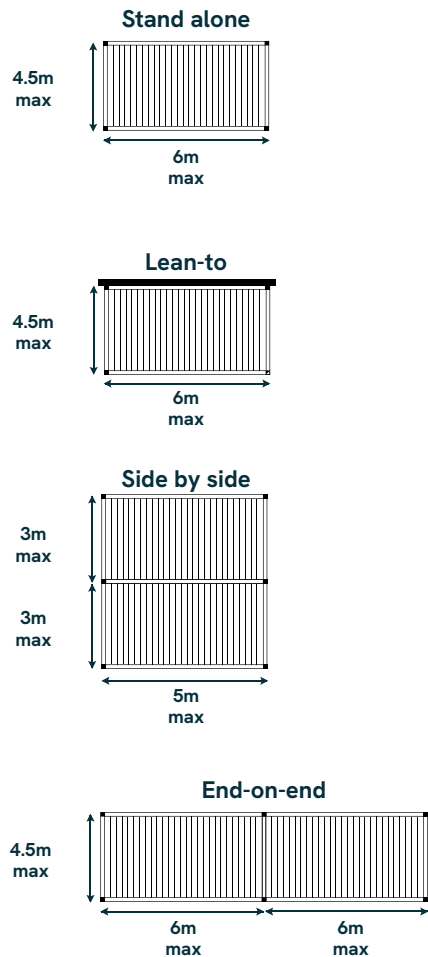

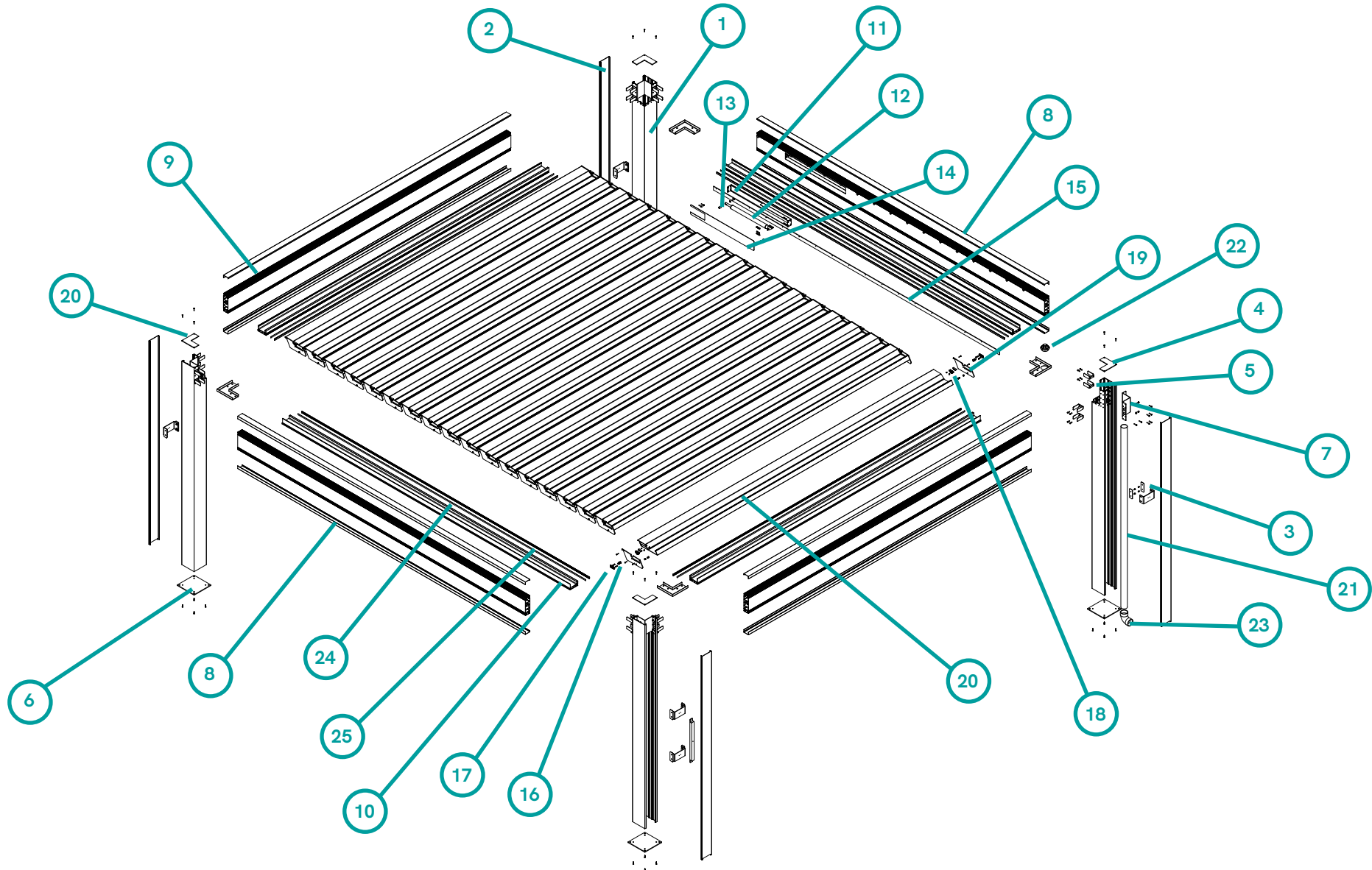

## Bioclimatic Pergola

Exploded Drawing



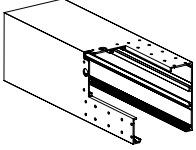
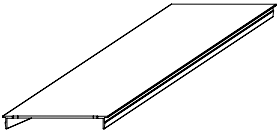
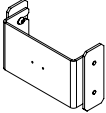
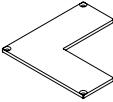
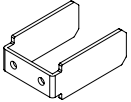
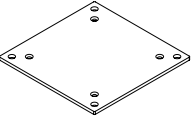
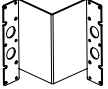
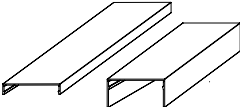

## Bioclimatic Pergola

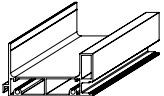
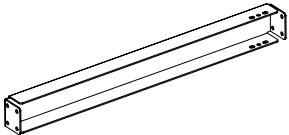
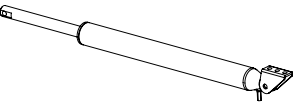
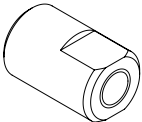
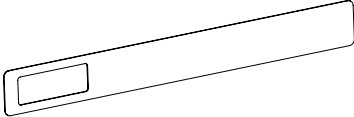
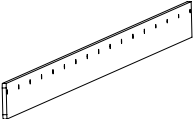
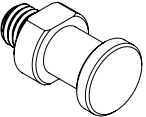
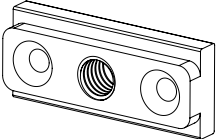
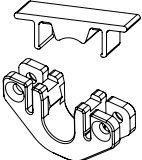
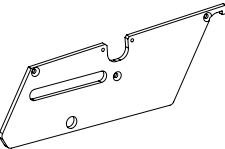
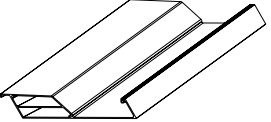
### Parts List

				
<b>1. Post</b>	<b>2. Post Cover Plate</b>	<b>3. Post Bracket</b>	<b>4. Post Top Plate</b>	<b>5. Connector Bracket</b>
				
<b>6. Base Plate</b>	<b>7. Internal Corner Plate</b>	<b>8. Edge Cap Profile</b>	<b>9. Perimeter Beam</b>	<b>10. Gutter</b>
				
<b>11. Motor Bracket</b>	<b>12. Motor</b>	<b>13. Motor Louvre Pin</b>	<b>14. Cover Plate</b>	<b>15. Louvre Linking Bar</b>
				
<b>16. Louvre Alex</b>	<b>17. Axle Insert</b>	<b>18. Connector</b>	<b>19. Louvre End Plate</b>	<b>20. Louvre</b>

## Bioclimatic Pergola

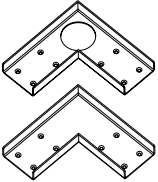
### Parts List

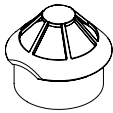
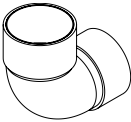
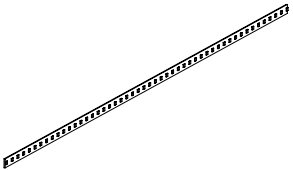
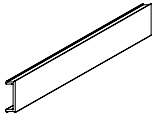
				
21. Gutter Corner Plate	22. Down Pipe	23. Leaf Guard	24. Elbow	25. LED Strip Light
				
26. LED Diffuser				

### Electrical Details:

**Motor:** Teleco Shaku 24V, 2500nm. IP66 rated. Remote controlled via handset.

**Lighting:** 24V, 8W per m, dimmable. IP65 rated.

## Bioclimatic Pergola

### Main Profile Dimensions

